

electriciQ

USER MANUAL



DESD8LW-V2 8L SMART DESICCANT DEHUMIDIFIER WITH HEATER

Thank you for choosing electriciQ.
Please read this user manual before using this innovative dehumidifier and keep it safe for future reference.

SETTLING IN OK?

We hope this has been helpful to you.

We would love to see how you're getting on with your new purchase, so please share any snaps you have on the platform of your choice below.

Our community awaits your uploads - Snap, tag and hashtag away!



@electriQUK

#electriQUK

WE'RE HERE TO HELP

Should you have any problems or questions with your purchase, please contact a member of our customer service team.

☎ 0330 390 3061

✉ support@electriQ.co.uk

Mon-Fri | 9am to 5pm

Unit 2A, Trident Business Park,
Neptune Way, Leeds Road,
Huddersfield, HD2 1UA

CONTENTS

SAFETY

| | |
|------------------------|---|
| Safety instructions | 4 |
| Safety protection tips | 5 |
| Visual safety guide | 5 |

OVERVIEW

| | |
|------------------------------|---|
| Features and Indicators | 6 |
| Before use | 7 |
| Positioning the dehumidifier | 7 |
| Setting up water drainage | 8 |
| Parts | 9 |

OPERATION

| | |
|-----------------------------|----|
| Control panel and functions | 10 |
| Display | 11 |
| Quick reference guide | 11 |

CONNECTION

| | |
|--------------------------|----|
| Setting up the wi-fi app | 12 |
| Registering app | 13 |
| Setting up home on app | 14 |
| Quick connection | 15 |
| AP mode connection | 16 |
| Smart scenes | 19 |
| Automation | 20 |

CARE AND MAINTENANCE 22

TROUBLESHOOTING 23

FAULT CODES 24

SUPPORT 25

TECHNICAL DATA 26

PSTI AND DECLARATION OF CONFORMITY 27

SAFETY INSTRUCTIONS

IMPORTANT

- Carefully read the instructions before operating the unit.
- This appliance is only intended for use in an indoor domestic environment. The manufacturer does not recommend any other use and may cause fire, electrical shock or other injuries to a person or damage to property.
- Rating: This unit must only be connected to an AC 220-240V / 50 Hz earthed outlet. Installation must be in accordance with the regulations of the country where the unit is used.
- If you are in any doubt about the suitability of your electrical supply, have it checked and, if necessary, modified by a qualified electrician.
- This dehumidifier has been tested and is safe to use. However, as with any electrical appliance – care must be taken during use.
- **CAUTION:** In order to avoid a hazard due to inadvertent resetting of the thermal cut-out, this appliance must not be supplied through an external switching device, such as a timer, or connected to a circuit that is regularly switched on and off by the utility.
- Disconnect the power from the appliance before dismantling, assembling or cleaning.
- Avoid touching any moving parts of the appliance.
- Never insert fingers, pencils or any other objects through the guard.
- This appliance is not intended for use by persons (including children) with reduced physical, sensory or mental capabilities. It is also not intended for use by those with a lack of experience and knowledge unless they have been given supervision or instruction concerning the use of the appliance by a person responsible for their safety.
- Children should be supervised to ensure they do not play with the appliance.
- Do not clean the unit by spraying it or immersing it in water.
- Never connect the unit to an electrical outlet using an extension cord. If a power outlet is not available, one should be installed by a qualified electrician.
- Never operate this appliance if the unit is damaged. Call the retailer first. Ensure the power cord is not stretched or exposed to sharp objects or edges.
- If the supply cord is damaged, it must be replaced by the manufacturer, its service agent or similarly qualified persons in order to avoid a hazard.
- R290 refrigerant gas complies with European environmental directives.
- R290 has a low GWP (Global Warming Potential) of 3.
- An authorised service representative should perform any service other than regular cleaning or filter replacement. Failure to comply could result in a voided warranty.
- The unit must be disconnected from the power prior to any cleaning, maintenance or servicing.
- This unit contains a UVC light source, which is inaccessible.
- The unit must only be opened by a suitably competent engineer when the power is disconnected and after reading the service manual.
- Unintended use or damage to the casing may result in the escape of dangerous UV-C radiation. UV-C radiation may, even in small doses, cause harm to the eyes and skin.
- Do not use the appliance for any purpose other than its intended use.
- Do not tilt the unit while in use. The unit is designed to work only in a vertical position. This dehumidifier must always be stored upright; otherwise, irreparable damage may be caused.
- This unit will still operate for approximately 3-4 minutes after pressing the power button to turn off.
- Never use the mains plug as a switch to start or turn off the dehumidifier. Instead, use the power button provided on the control panel.
- Always place the unit on a dry and stable surface.
- The appliance should not be installed in a laundry or wet room where the humidity is higher than 85% RH. This unit should be operated at an ambient temperature between 1°C and 32°C.
- Do not dry laundry directly above the unit. To prevent water from entering the dehumidifier, laundry should be placed at least 40 cm away from your dehumidifier.
- Do not place the unit next to heat sources (e.g. electrical fires, fireplaces, etc.)
- Do not store or use gasoline, petrol, paint, solvents or other flammable vapours and liquids in the vicinity of this dehumidifier or any other appliance. Do not use

dehumidifiers where flammable gases or VOC can be released or accumulate.

- Do not use or store the unit in a room smaller than 4m².

ENERGY SAVING AND UNIT SAFETY PROTECTION TIPS

Do not cover or restrict the airflow from the outlet or inlet grills.

For maximum performance, the unit should be operated at least 20 cm away from walls and 50 cm from other objects within the room. Whilst storing the unit when not in use, ensure the same ventilation clearances as in operation. Do not store anything on top or leaning against the unit.

Always store the unit in a dry room away from direct sunlight.

Keep the appliance's filters and grills clean. Under normal conditions, filters and grills should only need cleaning once every three weeks

(approximately). Do not use the unit without the mesh air filter, as this will allow dirt to gather inside the dehumidifier, which could invalidate the warranty.

A dirty filter restricts the airflow into the machine, increasing the resistance of the fan. This can damage the unit and invalidate your warranty.

Since the filters remove airborne particles, more frequent cleaning may be necessary depending on the air quality. Vacuum and wash the mesh filters with hot, soapy water and dry them before placing them back in the unit

QUICK VISUAL SAFETY GUIDE ON WHERE OR WHEN NOT TO USE YOUR DEHUMIDIFIER



Exposed to the weather outdoors



Near water



If the power cable wire are frayed or cut



Where small children may be left unattended



If an extension lead may become overloaded



If an extension lead may become overloaded



Where the power cable may be damaged



Where there is a risk of interference by foreign objects



On a slope or uneven surface



This product is not for DIY repair



Where there is a risk of fire, or close to a naked flame



Where there is a risk of water falling on the unit

WARNING SYMBOL



Read the
operating
instructions



Read the
operator's manual



UV Radiation



Read the
service/technical
manual

FEATURES:

Your DESD8LW-V2 is a top-of-the-range desiccant dehumidifier with features not found in other units.

1. Efficient, easy to use and quiet.
2. Intelligent CPU-controlled digital humidistat.
3. Control and monitor the humidity or temperature remotely using your Android or Apple phone/tablet.
4. Alexa and Google Home are compatible: Use voice commands to operate the smart dehumidifier conveniently.
5. Advanced scheduling abilities using the App.
6. Relative humidity adjustable between 40-80% with room humidity display.
Above 70%: Too humid
 $70\% \geq RH \geq 60\%$: Above recommended humidity.
 $60\% \geq RH \geq 50\%$: Ideal humidity level.
Below 50%: Too dry
7. Easy to use control panel with led indicators.
8. Ionizer, a pre-filter with PET materials.
9. Works very well at low temperatures compared with classic compressor dehumidifiers.
10. Standalone heater providing two levels of heat output with thermostatic control.
11. Heats the air passing through between 5-10°C, making the air dry and warm, reducing heating bills.
12. Tank full alarm and auto-stop function.
13. Recessed carry handle for portability

The DESD8LW-V2 desiccant dehumidifiers uses desiccant technology to extract water from the environment. Desiccant dehumidifiers are ideal both at standard and low temperatures, working in an ambient temperature range of between 5-35°C. The DESD8LW-V2 is light and easy to move, as it does not contain a heavy compressor. It also works intelligently as it is designed to extract unwanted humidity while saving money due to its advanced power-saving logic.

It features an intelligent digital humidistat with variable humidity settings between 40-80% RH, ensuring your room is not dried too much and power is not wasted.

OTHER FEATURES AND INDICATORS

TANK FULL LIGHT

The light will illuminate, and the unit will beep when the tank is ready to be emptied or if the water tank is incorrectly inserted. The water level control will shut off the dehumidifier until the tank has been emptied and replaced in its proper position.

AUTO-RESTART

When the unit is turned off in standby mode, it remembers the last setting when turned on again. If a power failure occurs, the unit can restart automatically and will retain its last settings except for the child lock and timer.

If the child lock or timer function is used, the unit will shut off when the timer has elapsed but will not retain these settings when turned on again.

LIGHTWEIGHT PORTABLE DESIGN ON CASTORS

The dehumidifier is built to be compact and lightweight. Your dehumidifier is an advanced micro-CPU-controlled device capable of self-diagnostics. The LCD display may also show errors and protection codes.

BEFORE USE

Remove any water from the water tank before starting the unit. Do not open windows or doors while the unit is running to save energy. Place the unit on a hard/flat surface. We would advise the unit to be left to run continuously for 24 hours on its first use.

TO REDUCE NOISE LEVELS:

Place a piece of carpet or a rubber mat under the unit to reduce any vibrations while the unit is running. For minimum noise, run the unit in sleep mode.

POSITIONING THE DEHUMIDIFIER

A badly positioned dehumidifier will have little effect. When positioning the dehumidifier, please ensure air circulation is not restricted around the unit.

Allow at least 20 cm of space around the unit. This dehumidifier is designed only for indoor residential or small office applications, and any commercial or industrial use will invalidate the warranty. For maximum efficiency, use in an enclosed area, closing all doors and windows to the outside to create an effective operating environment. Do not use outdoors.

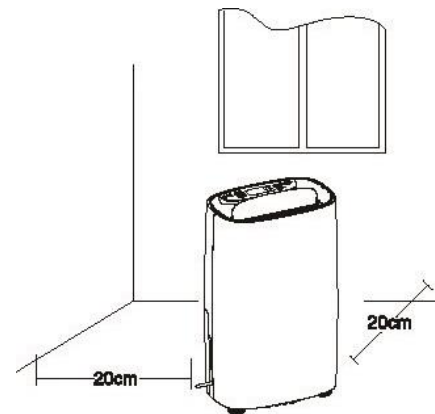

Your electriQ dehumidifier will begin to protect your space from the harmful effects of excessive moisture as soon as it is turned on. Excess moisture is dispersed throughout your home. For this reason, the dehumidifier should be positioned in a central and clear location so that it can draw this moist air towards it from all over the home. A warm hallway or landing is an excellent position for your dehumidifier. If possible, leave interior doors ajar to allow air circulation.

Alternatively, if you have a serious problem in one area, you can begin by positioning the dehumidifier there and moving it to a more central location later. For the most effective use, run your dehumidifier with external doors and windows kept closed. Please note that the unit should not be placed directly against a radiator or other heat source.

The water tank should be emptied before moving the appliance. When carrying the unit, it should be kept upright and sufficiently supported from its base. When positioning your electriQ dehumidifier, ensure that it is placed clear of any obstacle that may limit the air dehumidifier on a flat, dry surface.

NOTE: Forcing the castors over an uneven floor or thick carpet can damage them; always lift the unit with the handle instead. Do not move the unit with the tank full; always empty prior to moving to avoid spillages.

WATER DRAINAGE

When the water tank is full, the unit stops operating. The tank full light will show on the control panel, and the unit will bleep.

NOTE: Only empty the water tank when it is full or before moving or storing the unit. There are two ways to dispense collected water.

USE THE INTERNAL WATER TANK

When the tank is full, the unit automatically stops running, and the tank-full indicator lights up. Slowly pull out the tank by the handle. Empty the water tank and reinsert it into the dehumidifier. The tank must be in place and securely seated for the dehumidifier to operate again. The dehumidifier will restart when the tank is restored to its correct position.

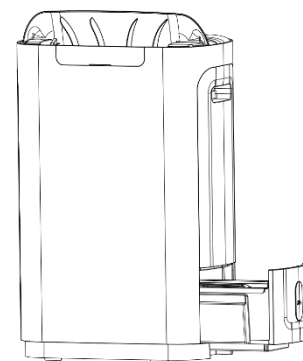

NOTES:

- Do not remove the water tank immediately after the unit stops. Please wait a while to prevent water from dripping into the unit and causing damage.
- Only empty the water tank when it is full or before moving or storing the unit.
- Do not rest the tank on the floor. The bottom of the tank could be uneven, and the tank may fall, causing water to spill.
- When you remove the tank, do not touch the sensors or any parts behind it. Doing so may damage the product. Be sure to push the tank gently all the way into the unit. Banging the tank against anything or failing to push it securely into place may prevent the unit from operating.
- Do not remove or damage the float switch in the water tank; otherwise, the machine will stop working.
- Please make sure the water tank cover is put back into place correctly before the water tank is reinserted.
- If the water tank is inserted incorrectly, the full tank indicator will illuminate. Remove and reinsert the tank to turn the indicator off and resume regular use.
- At all times, avoid letting water into the unit. It may cause an electrical hazard and damage it.

SET UP CONTINUOUS DRAINAGE

The dehumidifier has a continuous drain hole that can be connected to a plastic pipe with a length of 2m and an inner diameter of $\Phi 15 \times \Phi 18$ mm (Not Supplied). Water can be plumbed in or drained into a sink, a larger receptacle or through the wall into an outside drain. Please follow the steps below to set your unit up for continuous drainage.

1. Cut off the cover for the continuous drain on the back of the unit.
2. Pull out the water tank and connect a water tube with an inner diameter of 15mm to the drain connector, and ensure the connection is tight
3. Replace the water tank in position within the unit.

This unit uses gravity to dispose of the water collected, so the drain should be lower than the dehumidifier water outlet. Be sure to run the water pipe downward and let the water flow out smoothly. Do not kink or bend the pipe.

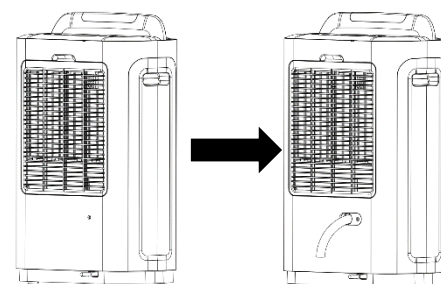

NOTE: When the continuous drain feature is not being used, remove the pipe installation to start collecting water in the water tank. The permanent drain can be used in conjunction with a water pump (e.g. when draining from a cellar) to lift the water upwards.

PARTS

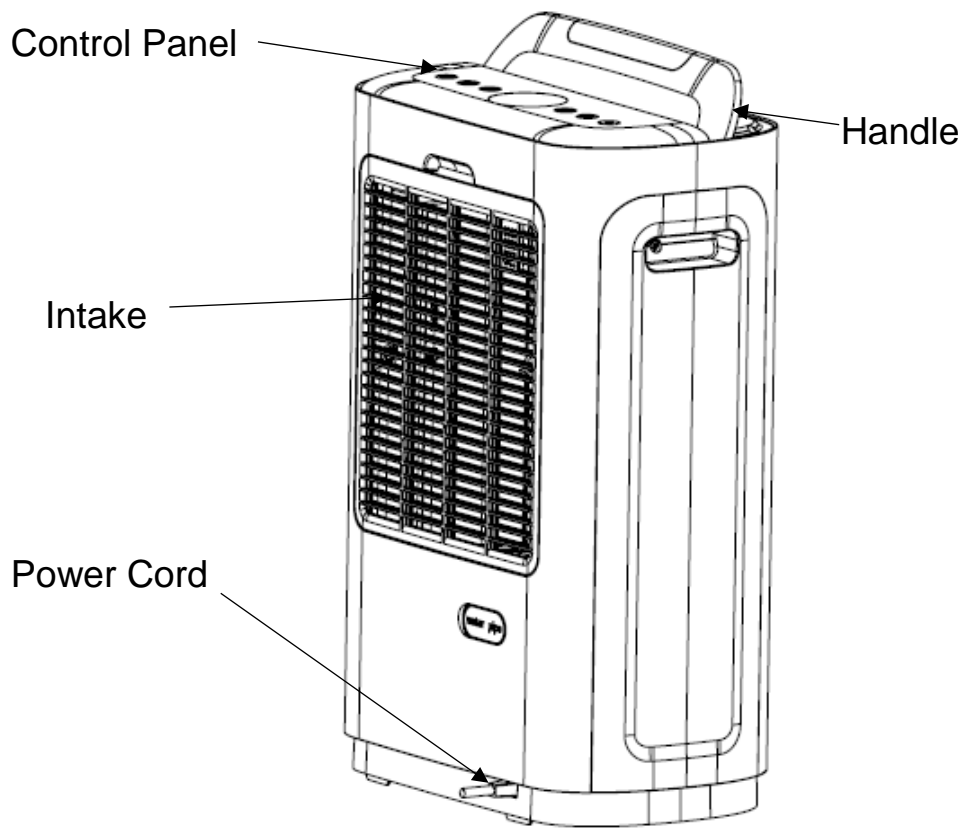
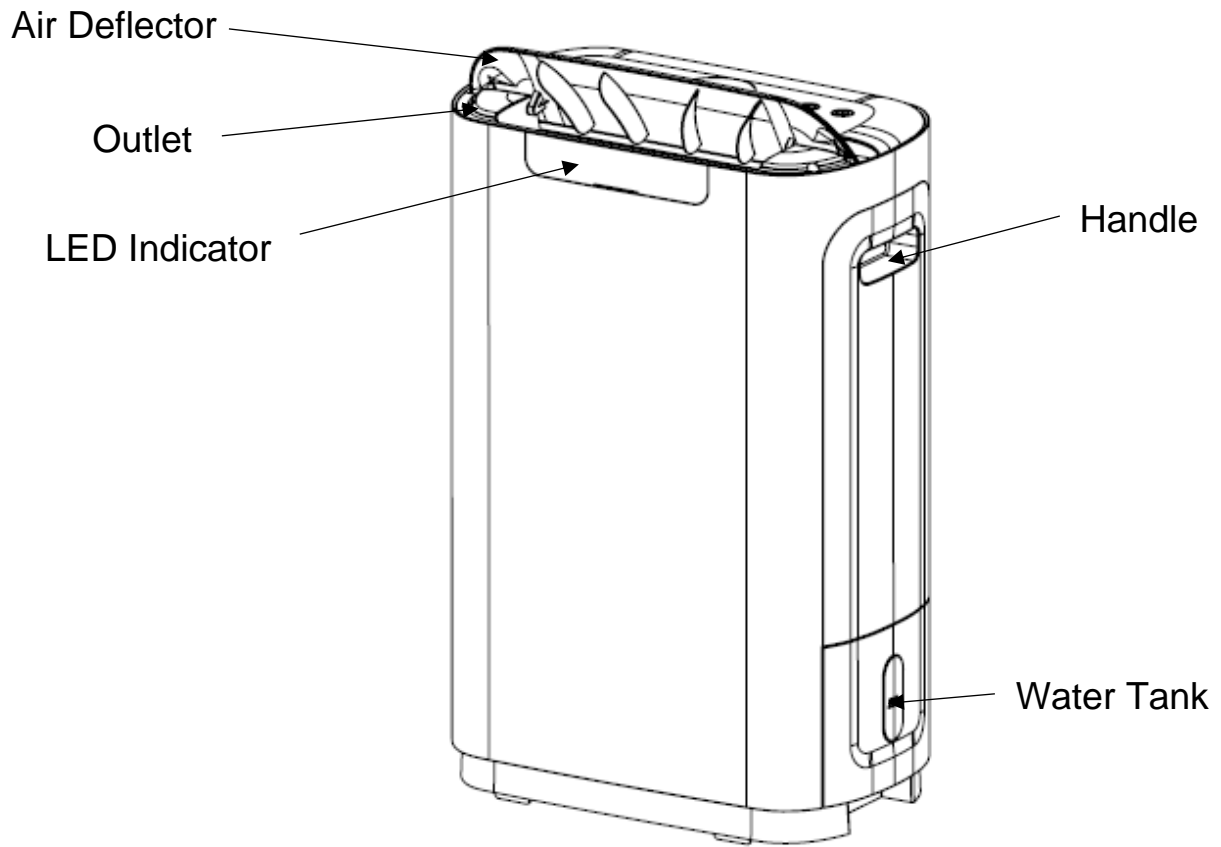

CONTROL PANEL









3" Wi-Fi

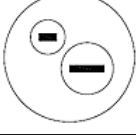

3" P3



| | |
|---|--|
|  | <p>POWER BUTTON Turn the appliance ON/OFF.</p> <p>Please note that after turning off the unit, it will take around 10 minutes to dry the zeolite disk before the operation stops.</p> |
|  | <p>FAN SPEED This allows the user to adjust the fan speed. Press the fan speed button to change the fan speed from Low → Medium → High → Auto, and then the cycle will repeat. When the unit works in fan-only mode, press the button to change the fan speed from Low → Medium → High → Auto, and then the cycle will repeat.</p> <p>Press and hold the button for 3 seconds to clean the P3 code. P3 code is a notice that the pre-filter needs cleaning.</p> |
|  | <p>OSC. (OSCILLATION FUNCTION) The Louvre will swing between 45 and 90 degrees.</p> <p>Press the button to turn the swing function on/off.</p> <p>WIFI Press and hold the button for 3 seconds to start pairing Wi-Fi.</p> |
|  | <p>PLASMA IONISER BUTTON (IONISATION FUNCTION) The ioniser can refresh the air while killing viruses, dust mites, mould and airborne allergens. Press the button to turn the ioniser function on/off.</p> |
|  | <p>TIMER BUTTON Press to set the timer. The timer will turn off the unit when the timer reaches the set time. The timer can be set from 0-8h. When the timer is set, the timer LED indicator will light up.</p> <p>CHILD LOCK Press and hold the timer button for 3 seconds to turn the child lock on/off. If the unit turns off and back on. The unit will no longer be in the child lock setting.</p> |

| | |
|---|--|
|  | <p>HUMIDITY Press the button to set the desired humidity. The order is shown below: CO→40%→45%→50%→55%→60%→65%→70%→75%→80%. CO is for continuous operation. In this setting, the unit will continue dehumidifying regardless of the humidity.</p> |
| <p>BUTTON SOUND</p> | <p>BUTTON SOUND Turn on/off the button beep. When the unit is working, press and hold the  &  buttons for 3 seconds to turn the button beep on/off.</p> |
| <p>TANK FULL</p> | <p>TANK-FULL If the water tank is full, the indicator light will flash, and the buzzer will beep 10 times. Please empty and clean the water tank to continue operation. The light will also illuminate if the tank is incorrectly fitted. Once refitted, the unit will operate.</p> |
| <p>OPERATION</p> | <p>OPERATION The operation light illuminates when the unit is running to extract moisture from the air. Please note that it may not light up immediately when the unit is started.</p> |

HUMIDITY LEVEL & TIMER 2 DIGIT DISPLAY

The led indicator performs the following functions:

WHEN THE UNIT IS PLUGGED IN: It will indicate the room's humidity level.

WHEN ONE OF THE HUMIDITY SETTING BUTTONS ARE PRESSED: It will indicate the desired humidity before reverting to showing the current humidity after a few seconds.

WHEN THE TIMER BUTTON IS PRESSED: It will indicate how many hours the timer function will operate before reverting to showing the current humidity after a few seconds.



QUICK REFERENCE GUIDE



POWER BUTTON: Press the power button to turn the dehumidifier on and off.



SWING CONTROL BUTTON: Press once to make the louvers swing and press again to lock at 45 degrees-90 degrees. Do not operate the unit if the self-opening louvers do not open when the unit is powered on.



TIMER BUTTON: Press the timer button to adjust the duration of the timer (1-8 hrs, start/stop timer).

IN POWER ON MODE: The number displayed will represent the number of hours the unit will run before turning off.

WHEN THE APPLIANCE IS RUNNING

1. When the room humidity level is lower than the target humidity, the heater will stop, and the fan will continue to run at a low speed for air circulation.
2. When the room humidity exceeds the desired level, the heater will reactivate to work for 4 hours and stop for 30 minutes as a circulation to extract the moisture.

Please Note: If a permanent drainage pipe is fitted, the unit will not stop operation. Setting the desired humidity to around 40% is good for a drying boost on the unit's initial run or in emergencies. It is not recommended to use it with these settings for regular operation in a domestic or office environment over a long period of time, as the air may become uncomfortably dry. To allow more moisture in the air, press the humidity button to set it to a higher percentage value (e.g. 60-70%).

CO-45% RH – Recommended for boosting drying and emergencies.

50-55% RH - Recommended setting, great for domestic operation and dry storage.

60% RH - Great for personal comfort and applications, where 50% RH is considered too dry.

70% RH—This is ideal for unoccupied properties or where an economical run is needed without the need to go drier than 70% RH.

SETTING UP THE WIFI APP

BEFORE YOU START

- Ensure your router provides a standard 2.4GHz connection.
- If your router is dual-band, ensure both networks have different network names (SSID). Your router's provider or Internet service provider can provide advice specific to your router.
- Place the dehumidifier as close as possible to the router during setup.
- Once the app has been installed on your phone, turn off the data connection and ensure your phone is connected to your router via WIFI.

DOWNLOAD THE APP TO YOUR PHONE

Download the "TUYA SMART" app from your chosen app store using the QR codes below or by searching for the app in your selected store.

Android



IOS



CONNECTION METHODS AVAILABLE FOR SETUP

The smart device has two different setup modes: CF (Quick Connection) and AP (Access Point). The quick connection is a quick and simple way to set the unit up. AP connection uses a direct local WIFI connection between your phone and the dehumidifier to upload the network details.

Before starting the setup, please ensure that your dehumidifier is in the correct standby mode for the connection type you are attempting; the display of your dehumidifier will indicate this.

To connect to the WIFI, press and hold the **SWING** button when the unit is in standby mode for approximately 3 seconds.

CHANGING BETWEEN CONNECTION MODES / WIFI RESET

To change the unit between the two connection types, hold the SWING button for 3 seconds. The frequency of the flashing Smart light signifies the connection mode. This will also remove any previous WIFI configuration.

| Connection Type | Frequency of Flashes |
|-----------------------|--------------------------|
| CF (Quick Connection) | Flashes once per second |
| AP (Access Point) | Flashes twice per second |

REGISTER THE APP

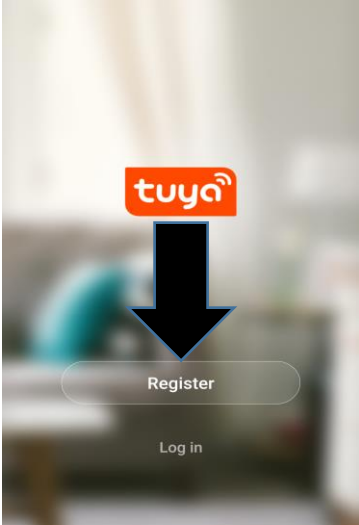
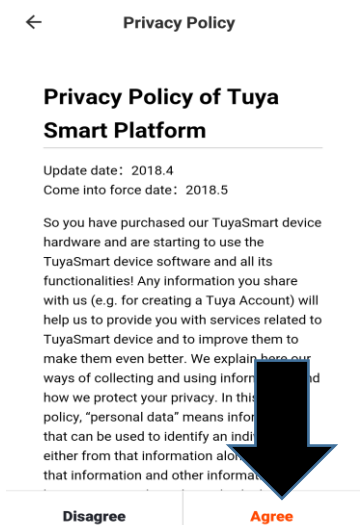
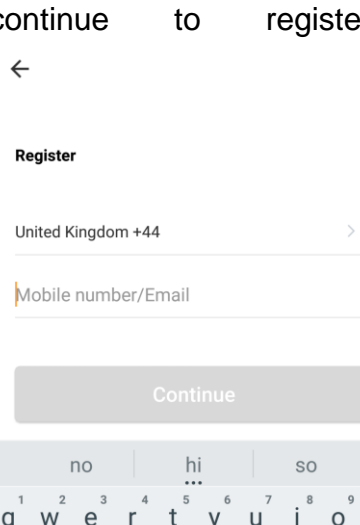
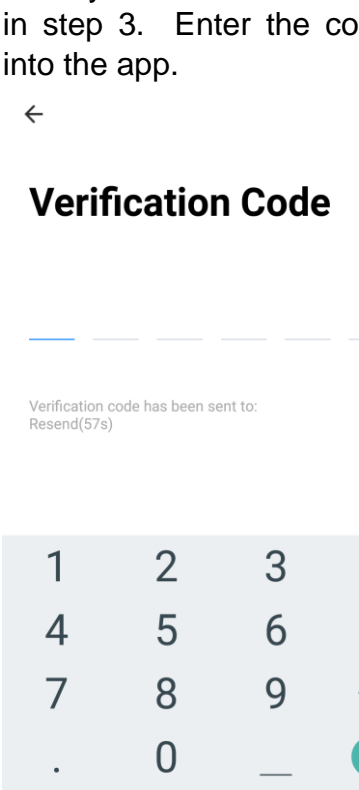
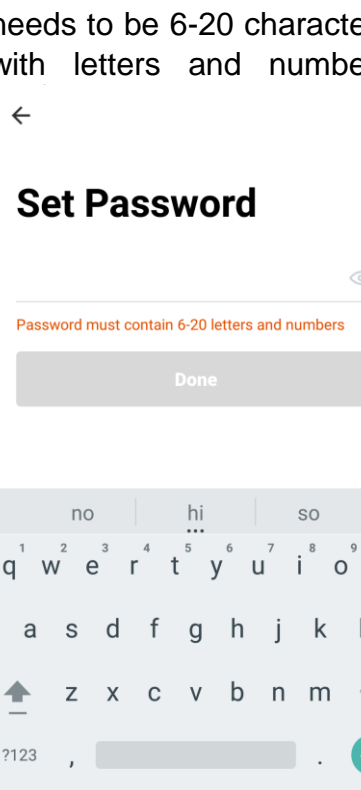
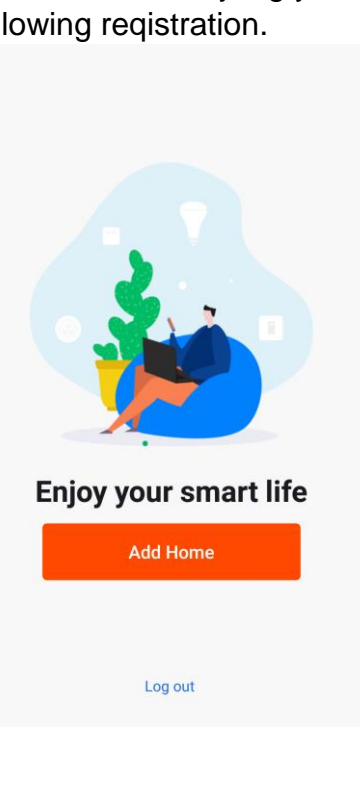
| | | |
|---|--|---|
| <p>1. Press on the register button at the bottom of the screen.</p>  | <p>2. Read the Privacy policy and press the Agree Button.</p>  | <p>3. Enter your email address or phone number and press continue to register.</p>  |
| <p>4. A verification code will be sent by the method selected in step 3. Enter the code into the app.</p>  | <p>5. Type in the password you would like to create. This needs to be 6-20 characters, with letters and numbers.</p>  | <p>6. The app is now registered. It will automatically log you in following registration.</p>  |

SETTING UP YOUR HOME WITHIN THE APP

TUYA is designed to work with a large number of compatible smart devices within your home and multiple devices within different houses. As such, during the setup process, the app requires that different areas be created and named to allow easy management of all your devices. When devices are added, they are assigned to one of the rooms you have created.

CREATING ROOMS

1. Press on the ADD HOME button.

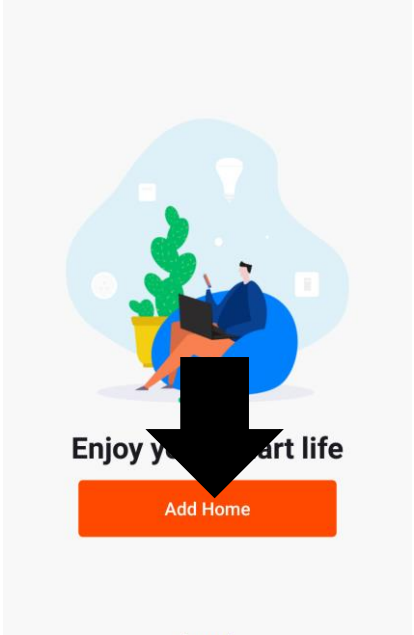

2. Type in a name for your home.
3. Press on the location button to select the location of your home. (See SETTING YOUR LOCATION below)
4. New rooms can be added by pressing the ADD ANOTHER ROOM option at the bottom. (See ADD ANOTHER ROOM below)
5. Untick any rooms that are not required on the app.
6. Press DONE in the top right corner.

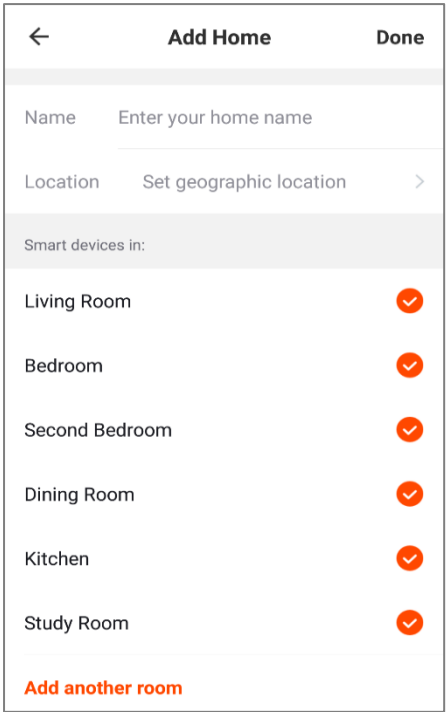

SETTING YOUR LOCATION

Use your finger to move the orange HOME symbol.

When the symbol is in the approximate location of your home, press the confirm button in the top right corner.

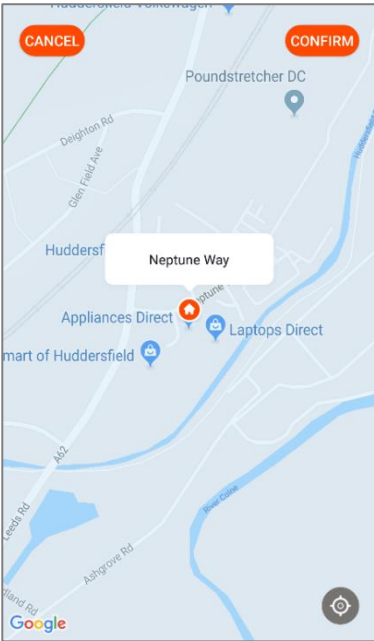

ADD ANOTHER ROOM

Type in the name of the room, and press Done in the top right corner.

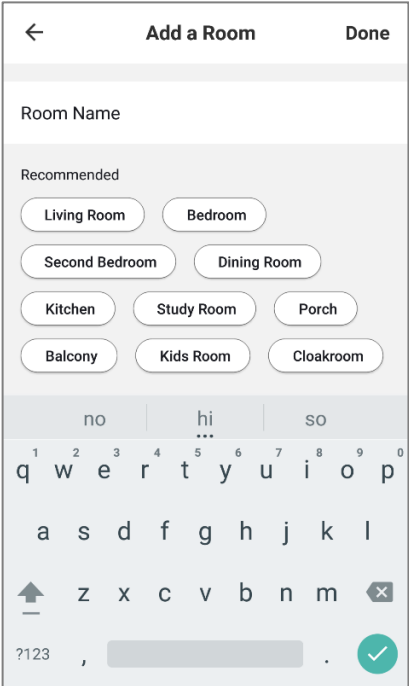

CONNECTING USING QUICK CONNECTION

Before initiating the connection, ensure the unit is in standby mode, with the WIFI light flashing once per second. If not, follow the instructions for changing the connection mode. Ensure your phone is connected to the WIFI network. (We advise turning mobile data off during setup)

1. Open app and press “+” to add device, or use the add device button.

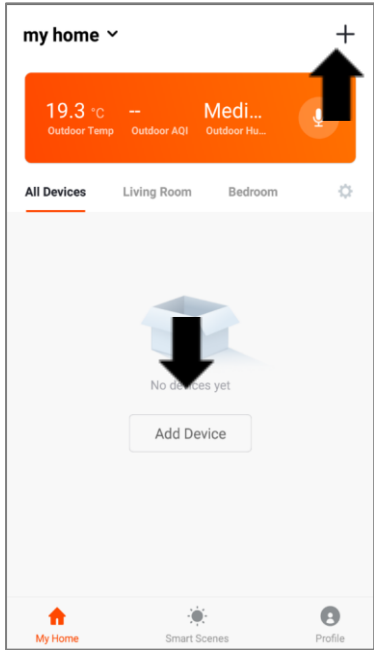

2. Select the type of device as “Dehumidifier” in the Small Home Appliance tab.

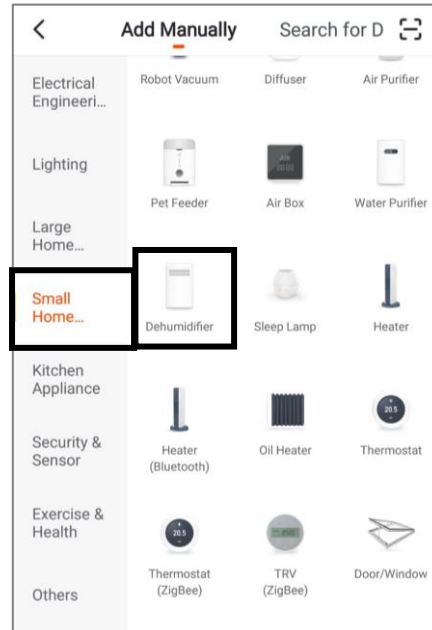

3. Enter your WIFI password and press confirm.

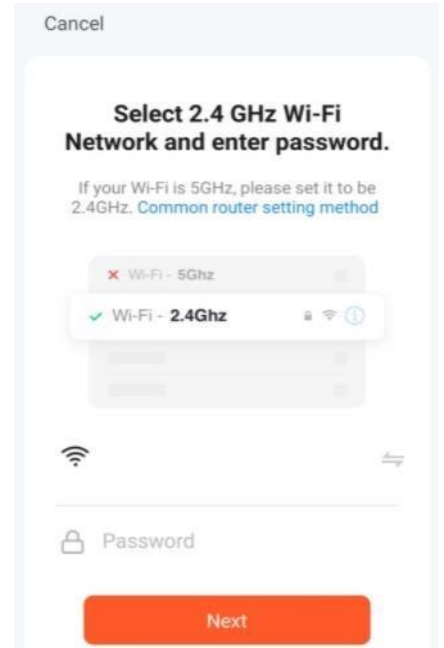

4. Ensure the WIFI light on the dehumidifier is flashing once per second then press on the orange button at the bottom of the screen to confirm.

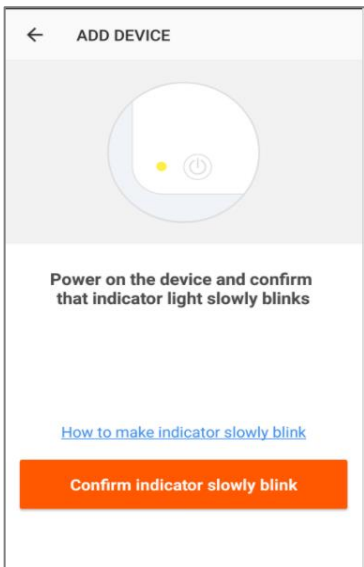

5. This will then transfer the settings to the dehumidifier. Wait for this to complete. If this fails, retry. If still unsuccessful please review the troubleshooting section for further help.

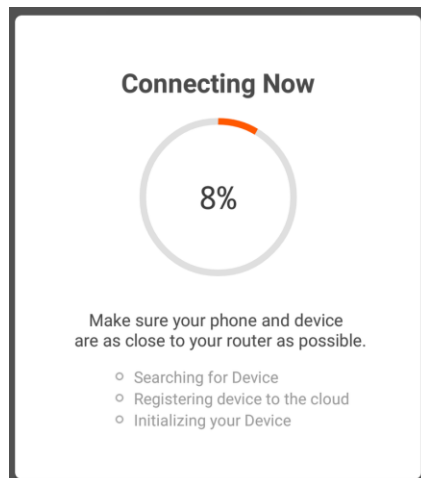

CONNECTING USING AP MODE (ALTERNATIVE METHOD)

Before initiating the connection, ensure the unit is in standby mode, with the WIFI light flashing twice per second. If not, follow the instructions for changing the connection type. Ensure your phone is connected to the WIFI network. (We advise turning mobile data off during setup)

1. Open app and press “+” to add device, or use the add device button.

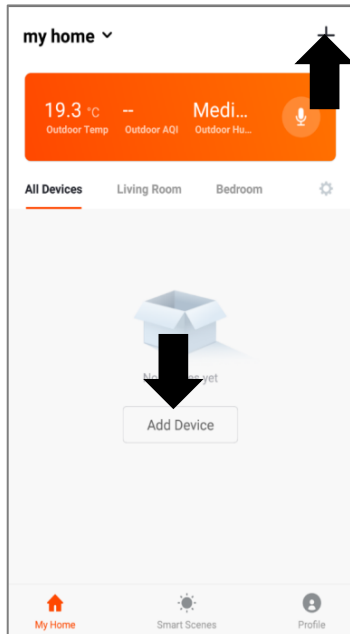

2. Select the type of device as “Dehumidifier”.

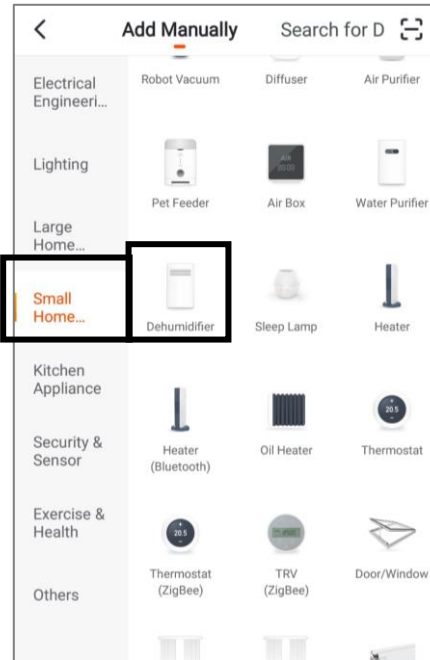

3. Enter your WIFI password and press confirm.

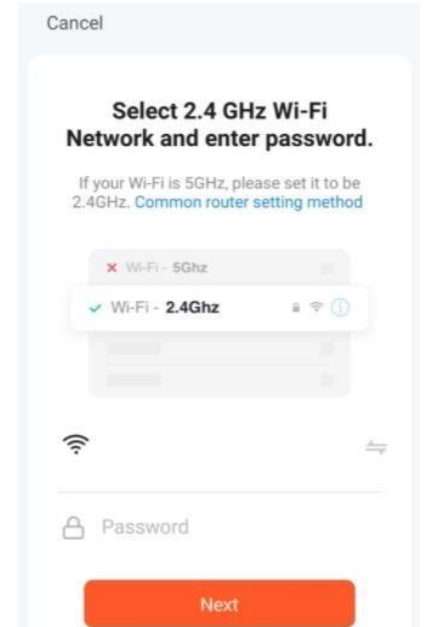

4. Ensure the WIFI light on the dehumidifier is slowly flashing (twice per second), then press on the orange button at the bottom of the screen to confirm.

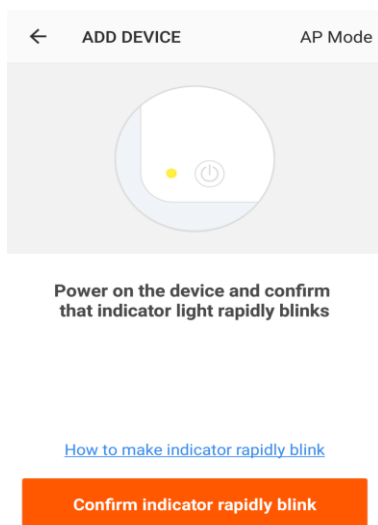

5. Connect your mobile to the hotspot the device has created by pressing “Go to connect”. Connect to the hotspot (no password required), before returning to the app.

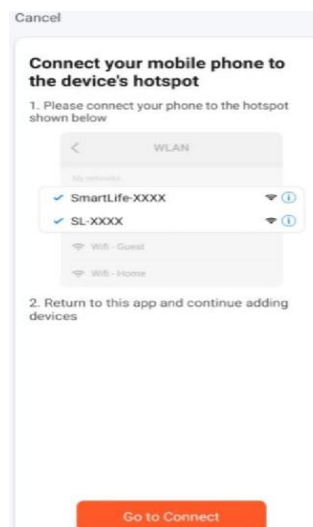

6. Go to network settings in your phone and connect to the “SmartLife xxx” connection. There is no password to enter. Then return back to the app to complete setup.

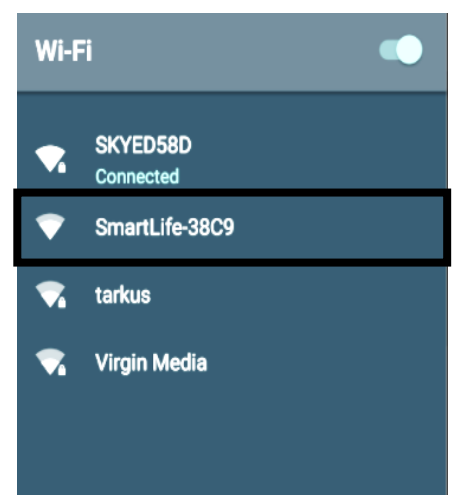

This will then transfer the settings to the dehumidifier. Once the connection process has completed, go back to the network settings on your phone to ensure your phone has reconnected to your WIFI router.

CONTROLLING YOUR DEVICE THROUGH THE APP

THE HOME SCREEN

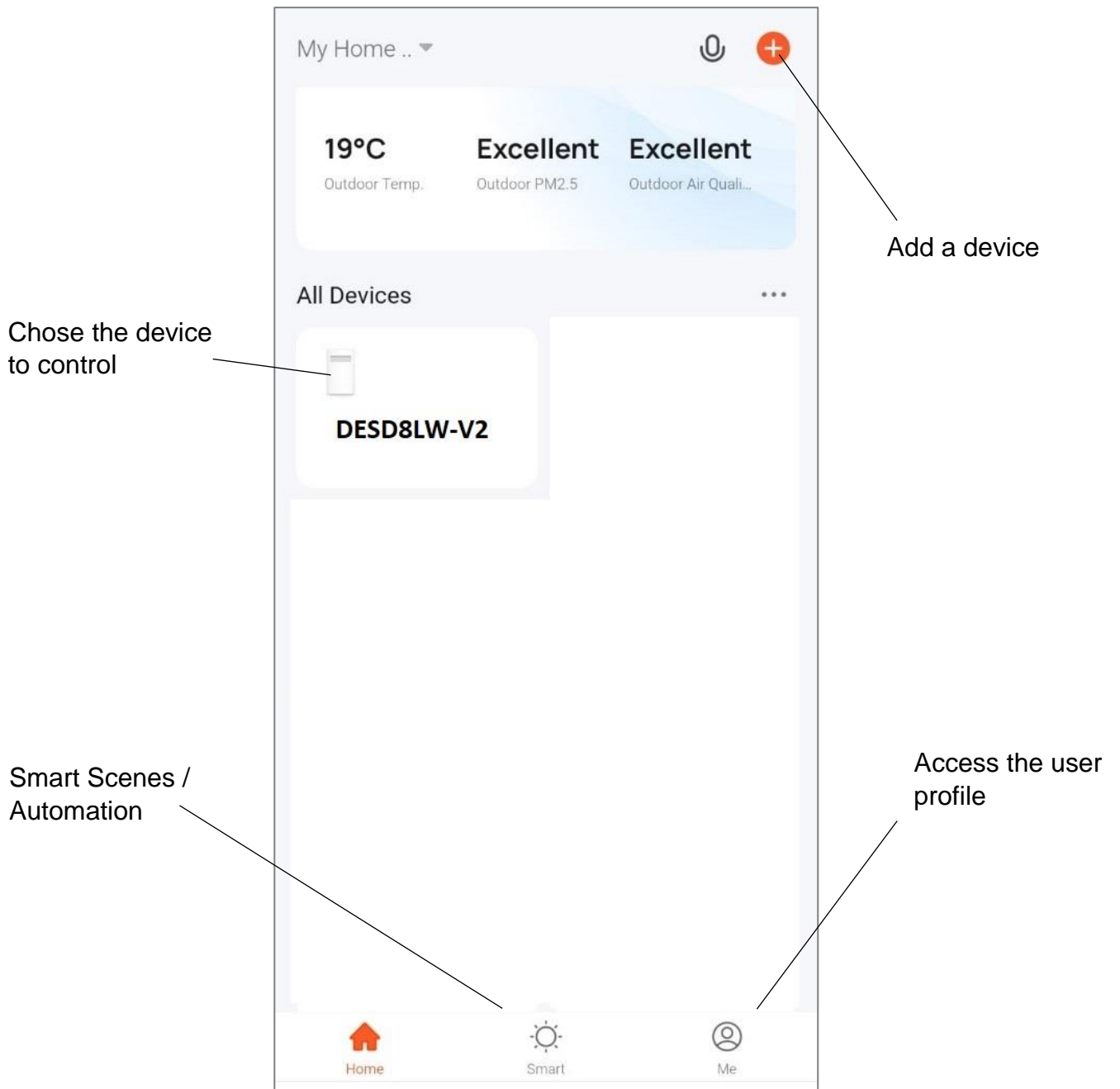

DEVICE SCREEN

The device screen is the main control screen for the dehumidifier, providing access to the controls to modify its functions.

Back: Returns to the Home Screen.

Indoor Temperature: Displays the current temperature of the room.

Countdown: Displays the current countdown.

Mode: Change between Dehumidify, Heating and Fan modes.

Home: Access the home section of the menu.

Back: Returns to the device screen.

Mode: Change between Dehumidify, Heating and Fan modes.

Swing: Activate and de-activate the movement of the louvers.

Child Lock: Enter the child lock mode. No functions will be available in child lock mode.

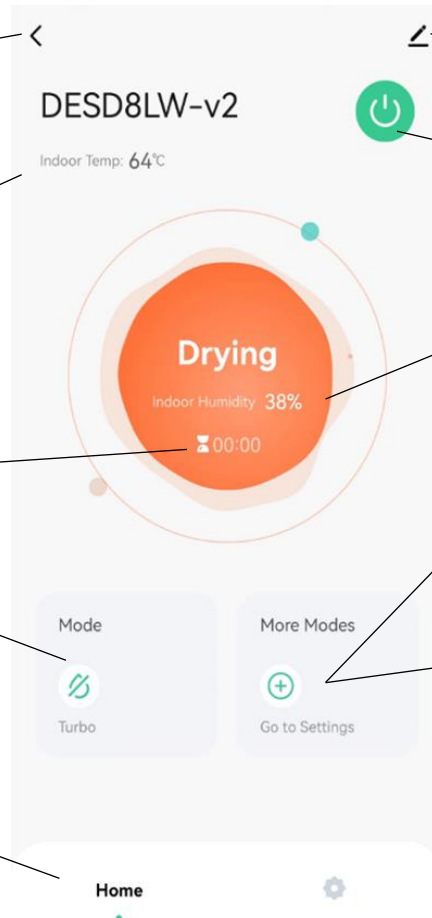

Profile: Use to change the name of the dehumidifier and amend user settings.

Power: Use to switch the unit on and off.

Indoor Humidity: Displays the current humidity of the room.

Settings: Access the settings menu.

More Modes: Access the sub menu for extra features and modes.

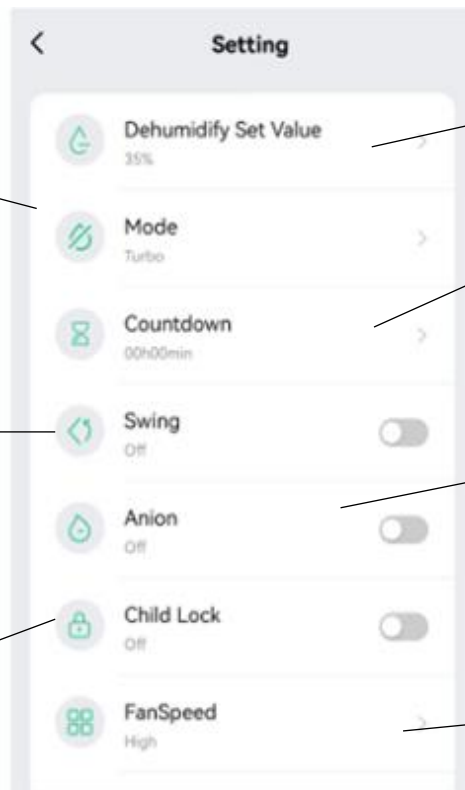

Set Humidity Level: Set the working humidity level.

Countdown: Set the countdown for the unit to turn off.

Ioniser: Pressing this button turns on the plasma ionizer. (Model Dependant)

Fan Speed: Set the current fan speed.

SMART SCENES

Smart Scenes is a powerful tool that allows the user to customise the dehumidifier's operation based on conditions within the room and outside influences. This gives the user the option of specifying much more intelligent actions. These are split into two categories: Scene and Automation.

SCENE

Scene allows for the addition of a one-touch button to the Home screen. The button can be used to change several settings in one go and all the unit settings. Several scenes can easily be set up, allowing the user to switch between preset configurations easily.

Below is an example of how to set up a scene:

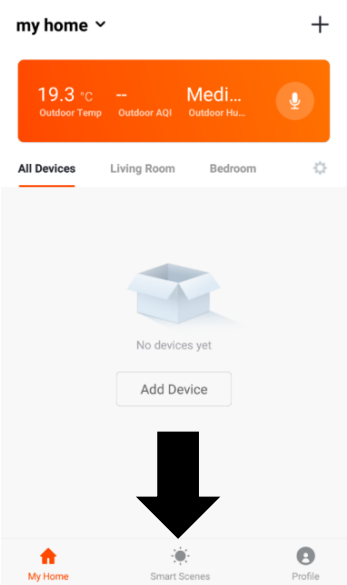
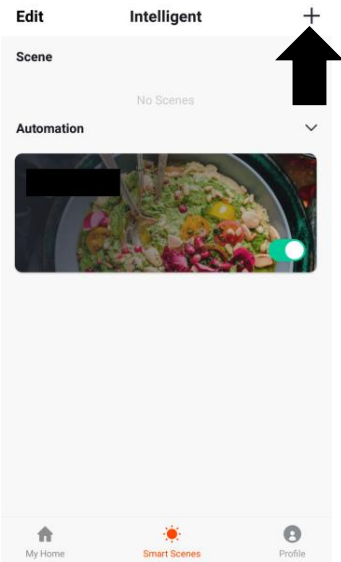
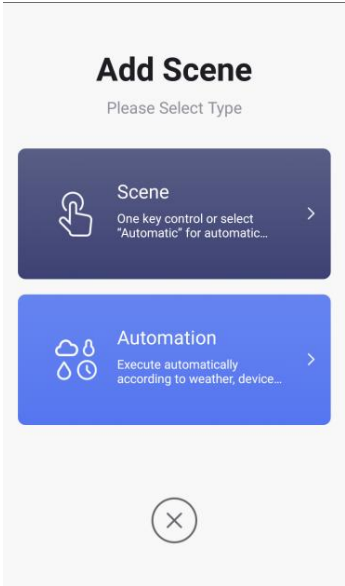
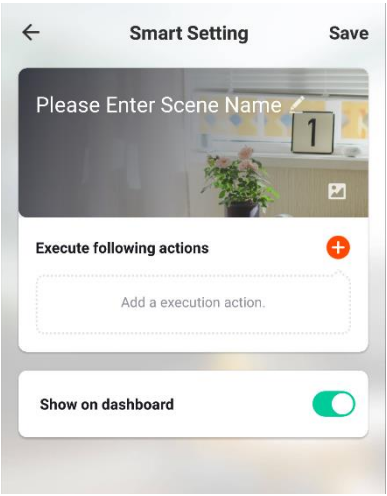
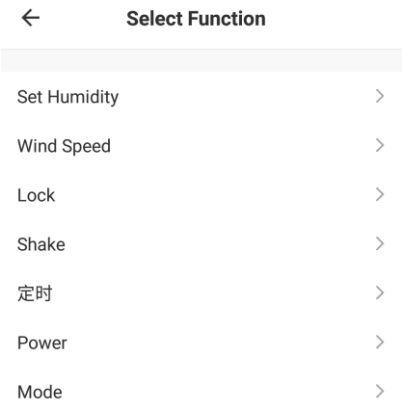
| | | |
|---|---|---|
| <p>1. Press on the Smart Scene tab at the bottom of the Home screen.</p>  | <p>2. Press on the Plus in the top right corner to add a smart scene.</p>  | <p>3. Select Scene to create a new Scene.</p>  |
|  | <p>4. Press the Pen next to "Please Enter Scene Name" to input the name for your Scene</p> <p>Show on Dashboard: Leave this on if you require the scene to be displayed as a button on the Home Screen</p> <p>Press the Red Plus to add the action required. Then select the dehumidifier from the list of devices.</p> | <p>5. Chose the function, set the value for the function, and then press the back button in the top right corner, to return to the previous screen.</p>  |
| <p>6. Once all the functions required have been added, press the Save button in the top right corner to finalise and save your new Scene.</p> | | |

AUTOMATION

Automation allows the device to be set up to take automatic action. This can be triggered by time, indoor temperature, humidity in the room, weather conditions, and a range of other factors.

DEVICE DETAILS SCREEN

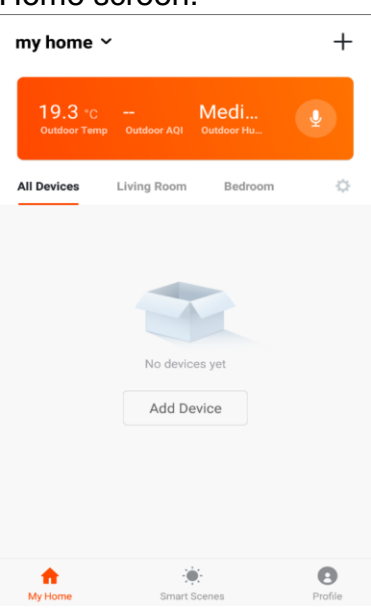
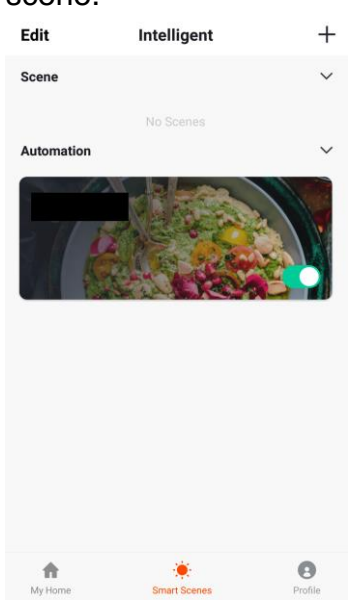
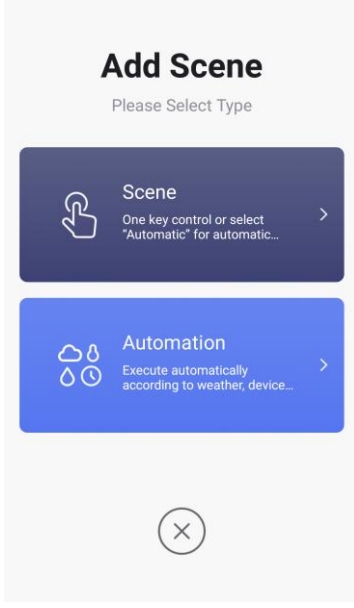
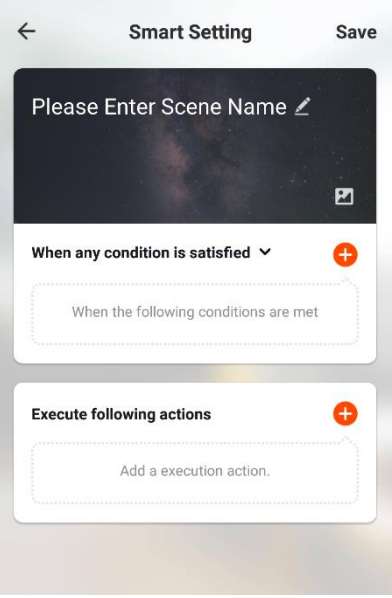
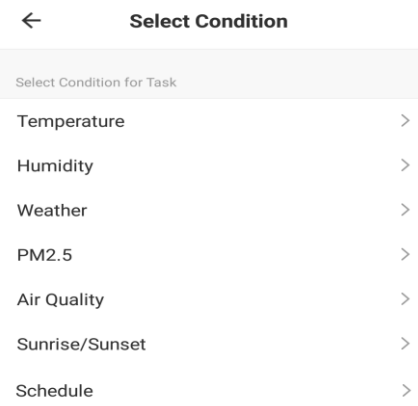
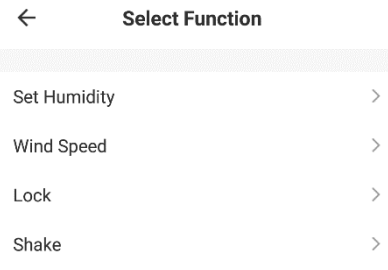
| | | |
|--|--|---|
| <p>1. Press on the Smart Scene tab at the bottom of the Home screen.</p>  | <p>2. Press on the Plus in the top right corner to add a smart scene.</p>  | <p>3. Select Automation to create a new Automation Scene.</p>  |
| <p>4. Setup is very similar to the scene setup on the previous page, and includes an extra section for specifying a trigger for the scene to start.</p> <p>Press the Pen next to "Please Enter Scene Name" to input the name for your Scene</p> <p>Press the Red Plus next to "When any condition is satisfied" to add the trigger.</p> <p>Press the Red Plus next to "Execute following actions" to add the action required. Then select the dehumidifier from the list of devices.</p>  | <p>5. Select the condition when the automation should start. A number of triggers can be combined.</p>  | <p>7. Once all the functions required have been added, press the Save button in the top right corner to finalise and save your new scene.</p> <p>The automation is now set up, it can be turned on and off using the toggle on the image shown on step 2.</p> |
| <p>6. Chose the function, set the value for the function, and then press the back button in the top right corner, to return to the previous screen.</p> |  | |

The device details screen allows you to edit the details of the device and use some of its additional features. It can be accessed from the device screen by pressing the symbol in the top right-hand corner.

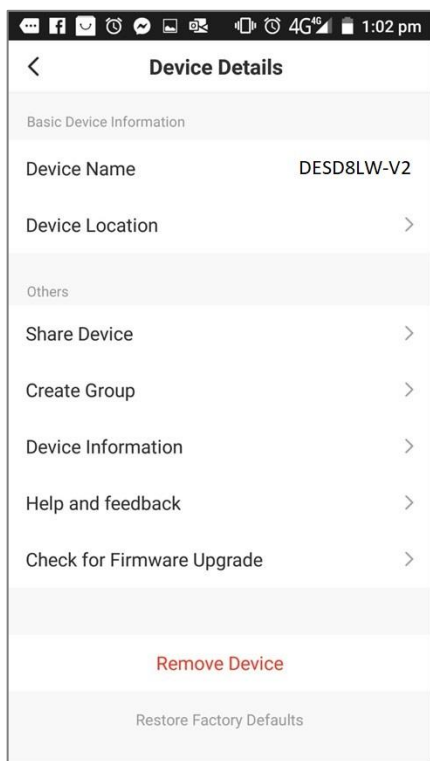

CHANGING THE NAME OF YOUR DEVICE

The top option within this allows you to change the name of the device to something relevant to the use of the product, such as “Living Room Dehumidifier”. You can also set up a pattern lock within the menu or change your password.

DEVICE SHARING

This allows you to share access to the controls of your dehumidifier with friends and family.

PROFILE TAB

The Profile tab allows you to make changes to the app, such as setting up a username and editing or adding rooms.

Within the Profile tab, you can also change settings related to the app itself.

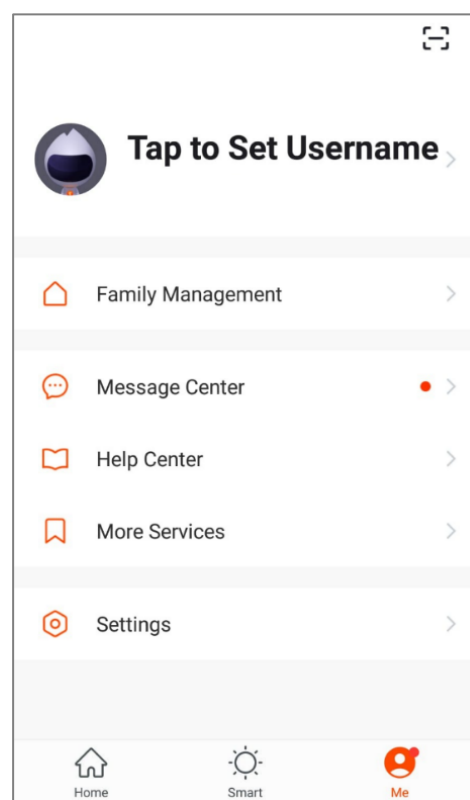

CONNECTION TROUBLESHOOTING

1. Check whether the device is powered on and is in the correct standby mode; if not, please refer to the CHANGING BETWEEN CONNECTION MODES section on page 14.
2. Ensure the WIFI password has been entered into the app correctly (Case sensitive)
3. Check that the phone is connected to the WIFI you are connecting the device to.
4. Ensure the network you are connecting it to is 2.4 GHz (5 GHz WIFI networks are not supported) and that there is a strong WIFI signal to the item.
5. If your router is dual band, ensure the 2.4 GHz network has a different name (SSID). Further advice on changing router settings will be available from your Internet service provider / Router manufacturer.
6. Check the settings on the router. Encryption should be WPA2-PSK, and the authorisation type should be set to AES
7. Try using the alternative connection method. i.e. If the connection is failing when attempting to connect through CF mode, try AP mode.

CARE AND MAINTENANCE

Always shut off the unit and unplug it from the mains before cleaning or performing any maintenance. When it is not in use for long periods, it is advisable to remove the plug from the power socket. Do not use chemical solvents (such as benzene, alcohol or gasoline), as they may cause irreversible damage to the unit.

FILTER CLEANING

The air inlet may easily gather dust; clean it often with a soft, damp cloth. If the filter is covered by dust, the unit's airflow and performance will be affected, and it may even cause damage. We recommend that you regularly clean the filters. The dehumidifier must be disconnected from the socket before maintenance, and the filters must be allowed to dry thoroughly before use.

1. Remove the filters from the unit and tap the dust away.
2. Clean the mesh filter with a vacuum cleaner or a soft brush.
3. If dirt and grease have accumulated, wash the mesh filter in hot soapy water.
4. Replace the filters in position.

NOTE: Never use the unit without the antibacterial mesh dust filter.

CLEAN THE GRILLE AND CASE

Use water and a mild detergent to clean the washable mesh filters. Do not use bleach or abrasives. Do not splash water directly onto the main unit. Doing so may cause electric shock, deterioration of the insulation, or rusting of the unit. The air intake and outlet grilles get soiled easily, so use a vacuum attachment or soft brush to clean them. Wipe the dehumidifier body with a soft, damp cloth or kitchen towel.

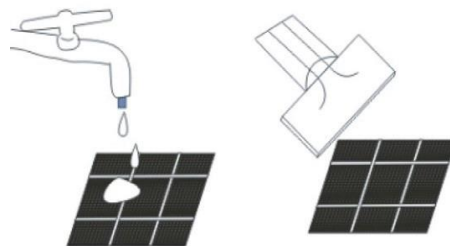

CLEAN THE WATER TANK

Clean the tank every few weeks to prevent the growth of mould, mildew, and bacteria. Partially fill the tank with clean water and add a little mild detergent. Swish it around before emptying and rinsing. **NOTE:** Do not use a dishwasher to clean the tank. After cleaning and drying, the tank must be reinserted securely into the dehumidifier in order to restart operation.

HEPA FILTER (OPTIONAL):

If using a HEPA filter, according to the time and frequency of use, it is generally recommended to replace the HEPA filter after about 3 months. The HEPA filter cannot be washed.

HEPA filters can be sourced from the supplier using the reference: **FIL-DESD8LW-V2HEPA**

END-OF-SEASON MAINTENANCE

1. Empty and clean the water tank.
2. Clean the unit and the filters per the above cleaning procedure.
3. Coil the power cord on the special cord storage rest at the back of the unit.
4. Cover the unit and keep it in a dry place.

POWER CORD MAINTENANCE AND REPLACEMENT

If the power cord is damaged, it could cause a short circuit or become a fire risk. Please avoid pulling, twisting, or pressing the cord, and keep it away from pets. If the power cord is damaged, power the unit off and unplug it immediately. Contact an electrician or service centre for repairs; do not attempt to repair the unit yourself.

TROUBLESHOOTING

| Problem | Possible Cause | Solution |
|---|---|---|
| The unit does not work. | Power is abnormal | Contact an electrician to perform a repair. |
| | Water tank displaced or full | Check the placement of the water tank or empty water tank. |
| | The room temperature is too high, or the air outlet is covered | Lower room temperature, clear air outlet |
| Poor performance | Filter is dirty | Clean the filter |
| | The door and windows are open. | Close the door and windows. |
| | Air-inlet or out-let is blocked. | Clean air-inlet air-outlet |
| Too Noisy | The unit is not placed on an even surface. | Place the machine on a flat surface. Add carpet or rubber mat underneath. |
| | Filter is blocked | Clean the filter |
| The device does not dehumidify. | The relative humidity in the room where the dehumidifier operates is too low. | The dehumidifier dries down to the target relative humidity set and will go into standby if the desired humidity has been reached. |
| The dehumidifier works, but relative humidity is still high | The place is too large. This dehumidifier can dry up to about a small five-bedroom house. | We recommend using a dehumidifier with a greater capacity. Call the customer service line for advice. |
| | There are too many sources of moisture. Bathing, washing, drying clothes, and cooking all add moisture to the air. | We recommend using a dehumidifier with a greater capacity. |
| | Paraffin or Calor gas heating can add too much moisture to the air | Consider using alternative heat sources |
| The windows were clear, and now condensation has returned. | The outside air temperature has dropped significantly, and the windows are colder. | Set the dehumidifier to 40%RH and run for longer. |
| I cannot remove the condensation from my windows, even in "Continuous" or "Laundry" mode. | The surface temperature of the windows is too low for a dehumidifier to prevent condensation. Common with single-glazed windows or poorly insulated houses when the outside air temperature drops below 0°C | Keep running the dehumidifier on "Laundry" 24 hours a day, and if the air temperature outside increases, the condensation on windows may clear. |
| The dehumidifier is blowing out warm air. | The dried air is passed over a heating element before being blown into the room as part of dehumidification. | This is normal and helpful, especially in cold weather; a dehumidifier is not an air cooler. |

| | | |
|--|---|--|
| Knocking noise coming from the dehumidifier | The motor wheel is low on lubrication, or dirt may have entered the motor ball bearings. | Run the dehumidifier in Laundry mode for two days to increase the lubrication; if the fault persists, call the service centre. |
| Water is not draining down the hose. | The hose is fitted for continuous drainage, but water goes into the tank. | Negative air pressure in the room pulls the water back into the dehumidifier overflow. Insert a 3 mm hole into the top of the tube 25 mm down from the spout. This will introduce air into the tube and balance out the air pressure. |
| | | Dirt is gathered in the internal tray. It may need servicing. |
| | | If the fault persists, then call the service centre. |
| The dehumidifier leaks water onto the floor | Usually, it means that the dehumidifier is not on a level surface or that the filter has not been cleaned often enough and dirt has fallen into the internal tray dehumidifier. | Check that the water bucket is not cracked by filling it with water and placing it on kitchen paper on the kitchen side. |
| | | Check if the filters are clean. |
| | | If the fault persists, then call the service centre. |
| The machine does not switch off the heater when the desired humidity is reached. | The temperature and relative humidity sensor that reads the room reading cannot read the correct readings. | Clean the filter and blow the air sensor with a hover or hairdryer on the COLD setting to clear the sensor of dirt. |
| | | Unplug the dehumidifier for 10 minutes to reset the PCB, then turn it back on. |
| | | If the fault persists, then call the service centre. |
| When pressing power off, the fan works for around minutes and switches off. | Unit is drying/cooling internally before going into off mode | Normal operation. DO NOT remove power until this has finished. |

Note: When the solutions above cannot solve the fault, please contact the service centre for help and do not attempt repairs.

| Error code | Reason |
|------------|---|
| C1 | NTC1 is open cut or shortcut |
| C2 | NTC 2 is open cut or shortcut |
| C3 | NTC1 & NTC 2 are open cut or short cut |
| C4 | The sync motor is a failure. |
| P3 | Pre-filter clean notice |
| 88 | Temperature and humidity sensor failure |

FREQUENTLY ASKED QUESTIONS

WHY DOESN'T THE UNIT WORK /OR STOPS SUDDENLY?

The water tank may be full or displaced. Empty the tank and carefully replace it in the unit to rectify it.

WHY DOES IT REQUIRE EMPTYING VERY REGULARLY?

When you first use your dehumidifier, it will work harder to reduce the room humidity down to 50%RH (SMART mode or the desired humidity set in dehumidifier mode). This is the time when it will produce the most water and, as such, will require emptying most frequently (even 2-3 times /day). As the room becomes dryer, the dehumidifier will collect less water, and it will take longer to fill the tank; this is perfectly normal. When the target relative humidity has been reached, the dehumidifier will stop collecting water and will operate for more extended periods in fan-only mode; this is regular operation. The intelligent logic of your machine will save you money.

WHAT DESIRED HUMIDITY SHOULD I SET THE DEHUMIDIFIER TO?

Unless you are using the unit to dry clothes, we recommend setting the desired humidity to between 50 and 60%.

For unoccupied properties, garages, etc., set the unit to 60-70%RH with the fan in normal or sleep mode according to your needs. That will ensure minimum power consumption while preventing moisture-related issues.

THE ROOM HAS REACHED THE DESIRED HUMIDITY BUT IS STILL HAVING PROBLEMS WITH CONDENSATION

If you find that you still have condensation on your windows or you need to dry the air further, set the unit to 40%RH or continuous mode with the fan set to turbo mode. This may be necessary if you have single-glazed windows, the house is poorly insulated, or the outside air temperature drops towards freezing. Using the unit in turbo mode will add more heat to your room and reduce your heating bill, as dry air will heat quickly.

electriQ UK SUPPORT

For your convenience, make these simple checks before calling the service line.

1. Has the unit been standing upright? (for at least 2 hrs)
2. Is the unit plugged into the mains? Is the fuse OK?
3. Switch the unit on and wait three minutes to see if the issue is resolved.
4. Check whether the water tank is full.
5. Have you followed the troubleshooting procedures?

If the unit still fails to operate, call 0330 390 3061 or complete the online form.

Office hours: 9 AM - 5 PM, Monday to Friday

www.electriQ.co.uk

Unit 2A, Trident Business Park,
Neptune Way, Leeds Road, Huddersfield, HD2 1UA

TECHNICAL DATA

| | |
|--|----------------------------|
| Model No. | DESD8LW-V2 |
| Rated Voltage | 230V ~ 50Hz |
| Dehumidify Capacity | 8L / day (at 20°C / 60%RH) |
| Max Rated Input Power | 610 W |
| Tank Capacity | 2.0 litres |
| IP Rating | IPX0 |
| Air Volume | 150 m ³ /h |
| Noise level | ≤48 dB(A) |
| Dimensions mm (LxWxH) | 358 x 213 x 537 |
| Net Weight | 8.6 kg |
|   | |

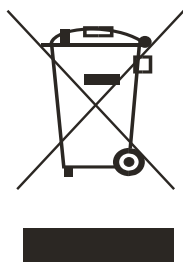

Disposal: Do not dispose of this product as unsorted waste. Collection of such waste must be handled separately as special treatment is necessary.

Recycling facilities are now available for all customers at which you can deposit your old electrical products. Customers will be able to take any old electrical equipment to participating sites run by their local councils. Please remember that this equipment will be further handled during the recycling process, so please be considerate when depositing your equipment. Please contact the local council for details of your local household waste recycling centre

PSTI STATEMENT OF COMPLIANCE

Description: 8L Smart Desiccant Dehumidifier

Model Number: DESD8LW-V2

Manufacturer: electriQ, 2A Trident Business Park, Leeds Road, Huddersfield, HD2 1UA

PSTI Contact: TiSecurity@buyitdirect.co.uk

We have prepared this statement of compliance and can confirm that this product is compliant with the deemed compliance conditions in Schedule 2 of The Product Security and Telecommunications Infrastructure (Security Requirements for Relevant Connectable Products) Regulations 2023.

Duration of security updates: 31/12/2029. This date is correct at the time of printing, but we may extend it. Please visit www.electriQ.co.uk for the latest information and details of our PSTI compliance.



Richard Leach

Compliance and Quality Manager, Buy It Direct, Huddersfield

21st August 2024

EU DECLARATION OF CONFORMITY

Hereby, electriQ declares that these air conditioners are in compliance with Directive 2014/53/EU. The full text of the EU declaration of conformity is available at the following internet addresses:

<https://www.electriq.co.uk/content/DOC/EU/DESD8LW-V2.pdf>

UK DECLARATION OF CONFORMITY

Hereby, electriQ declares that these air conditioners are in compliance with Radio Equipment Regulations 2017. The full text of the UK declaration of conformity is available at the following internet addresses:

<https://www.electriq.co.uk/content/DOC/UK/DESD8LW-V2.pdf>